

INTRODUCTION AU FER

L'histoire du fer en Belgique - 17 images

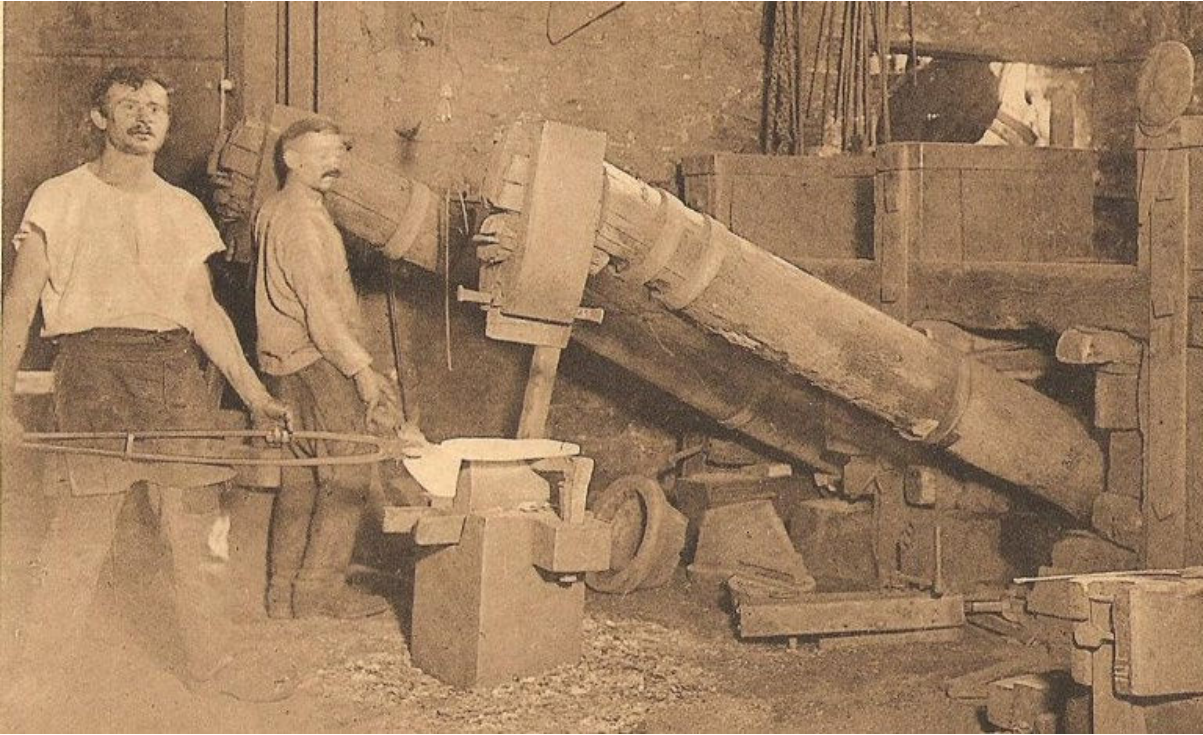

Minerai de fer



Charbon de bois



Bas-fourneau



Loupe de fer



Lingot de fer



Lingot façonné par le forgeron/ferronnier/maréchal-ferrant

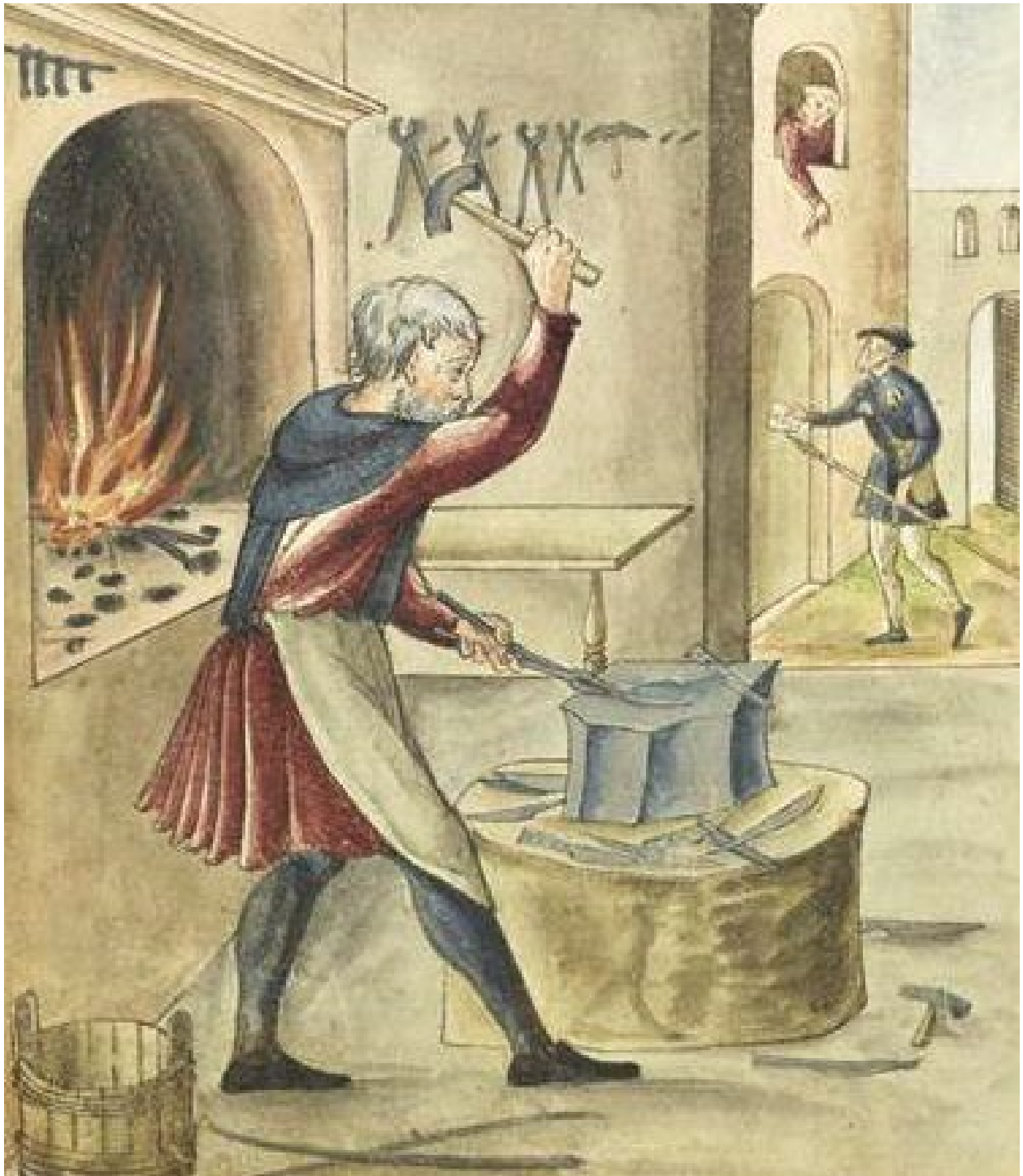



ancre



penture

Haut-fourneau

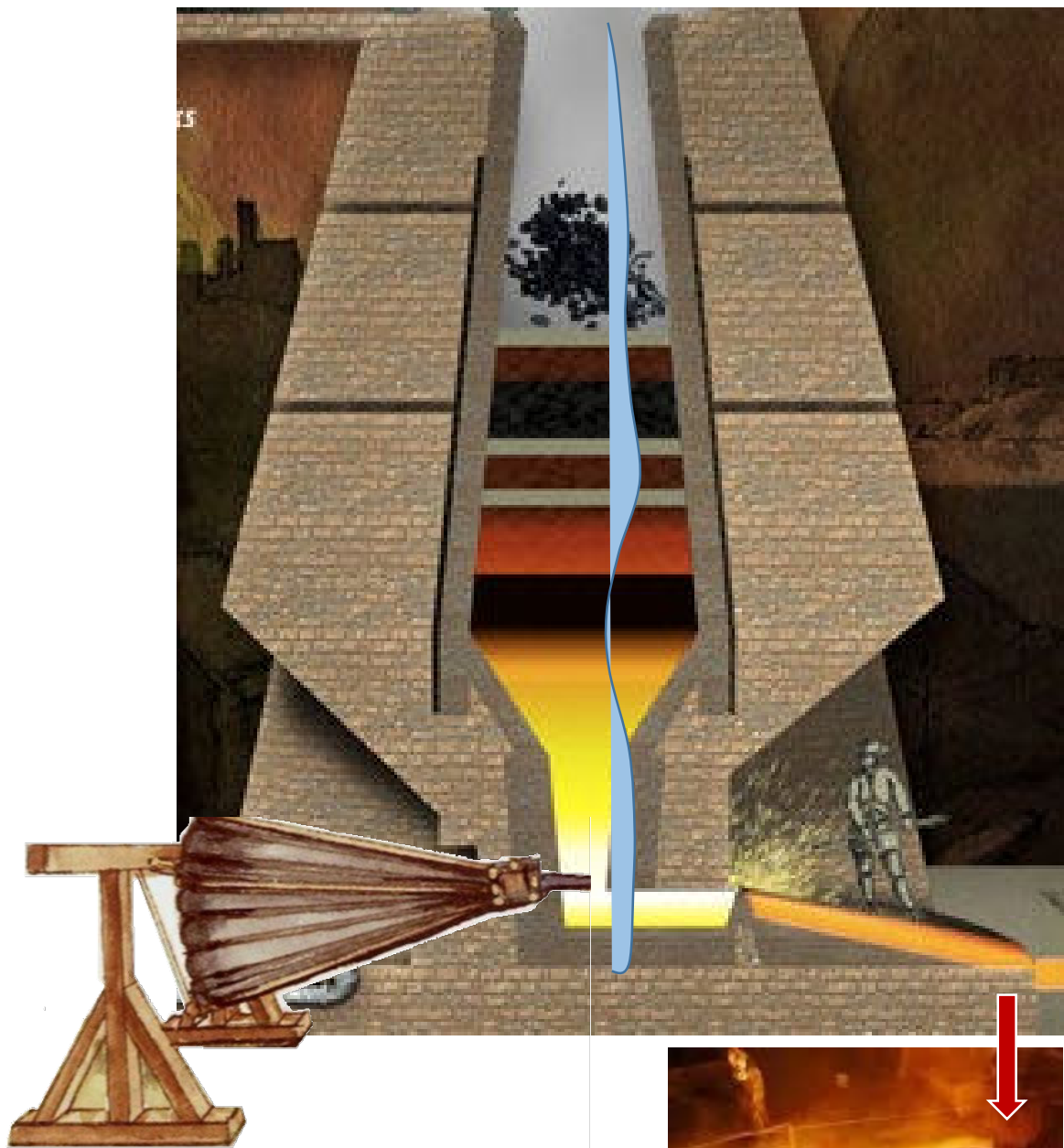

= fonte liquide

Gueuse

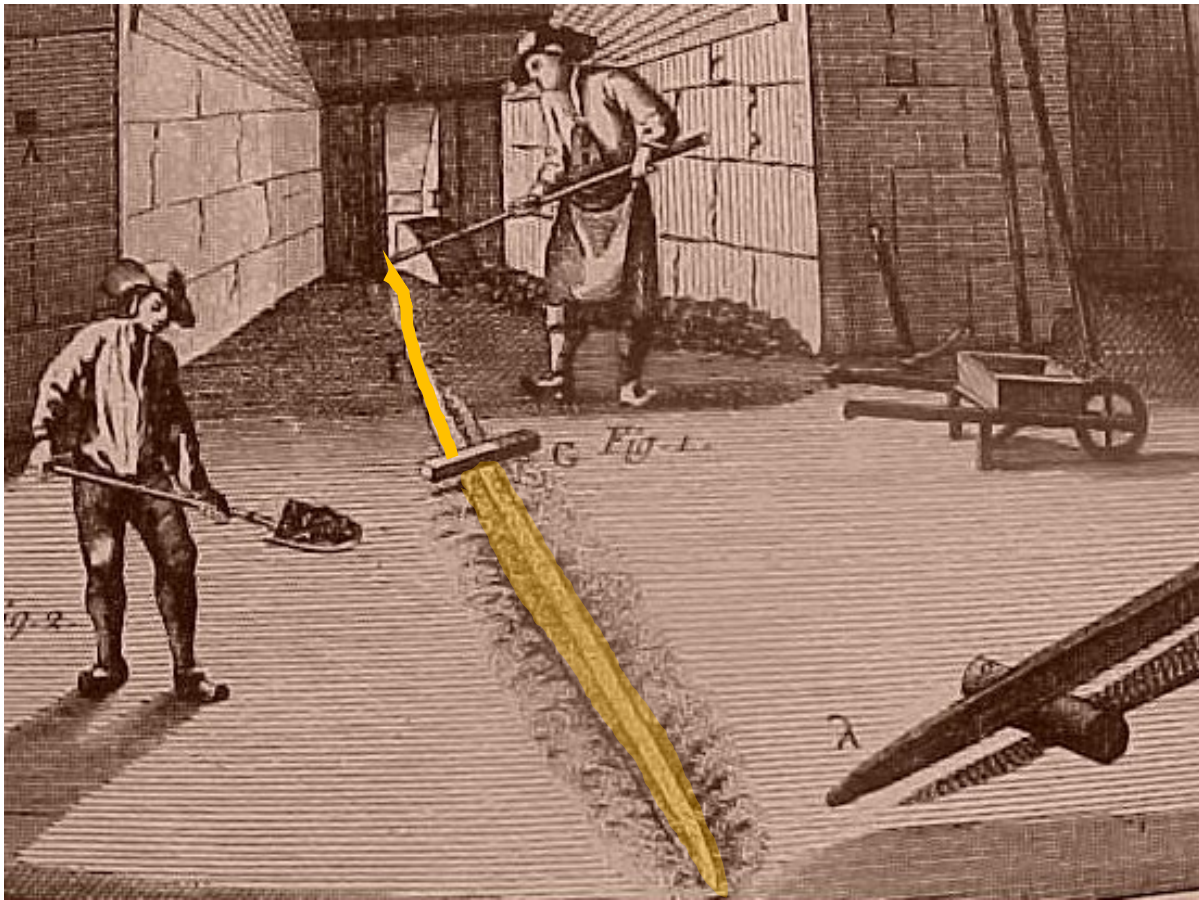

Fonte



Léonard Defrance, Intérieur de fonderie, vers 1790, MRBAB

Affinage

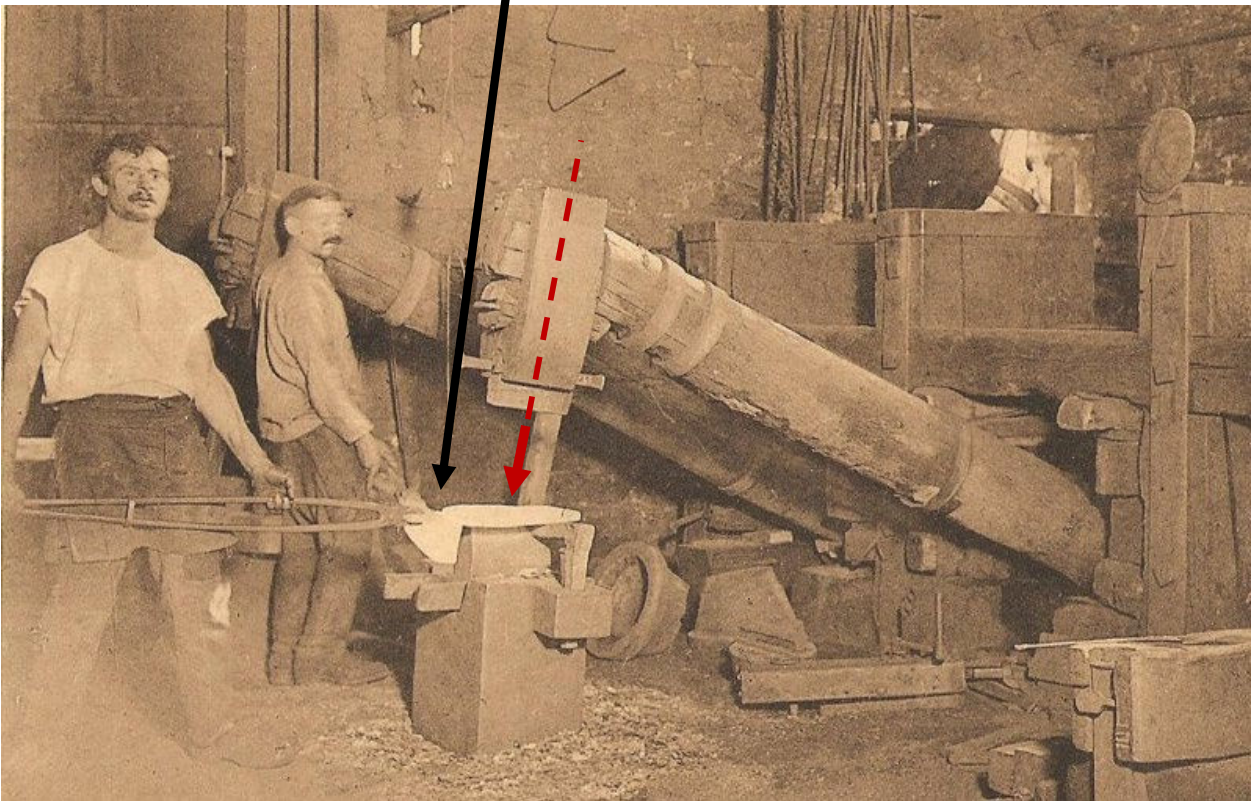
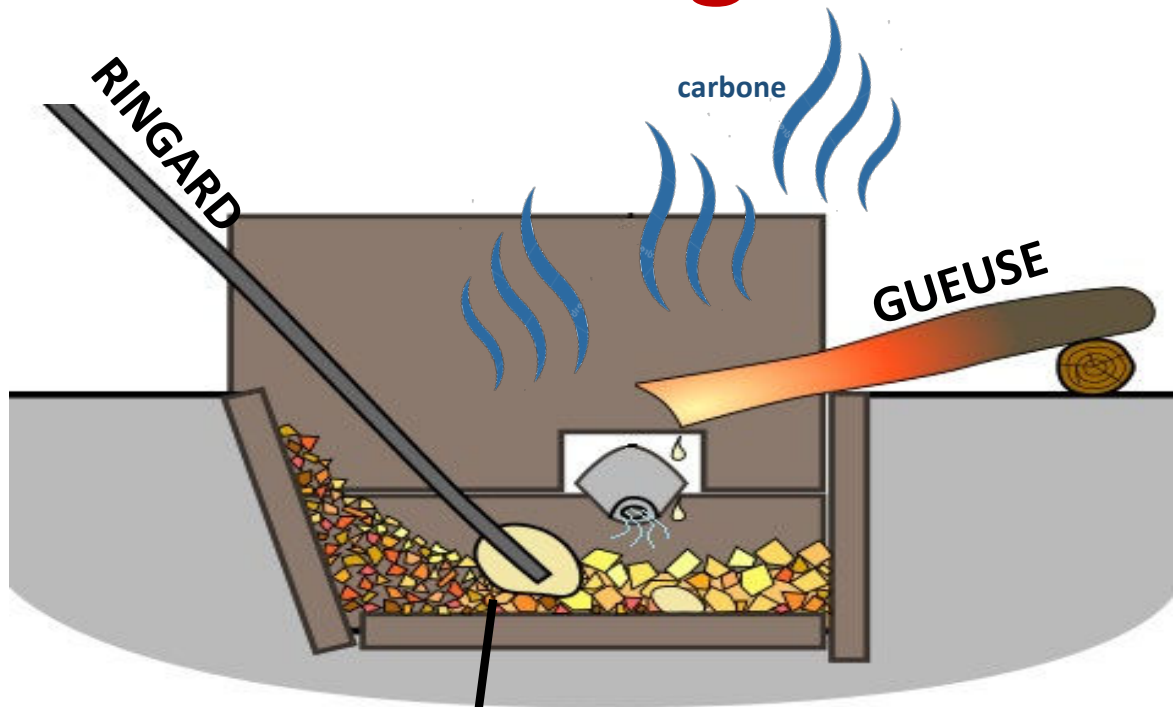



Joseph Wright of Derby, *Iron forge*, 1772

Nouveau combustible = le coke



Nouveau four ► acier

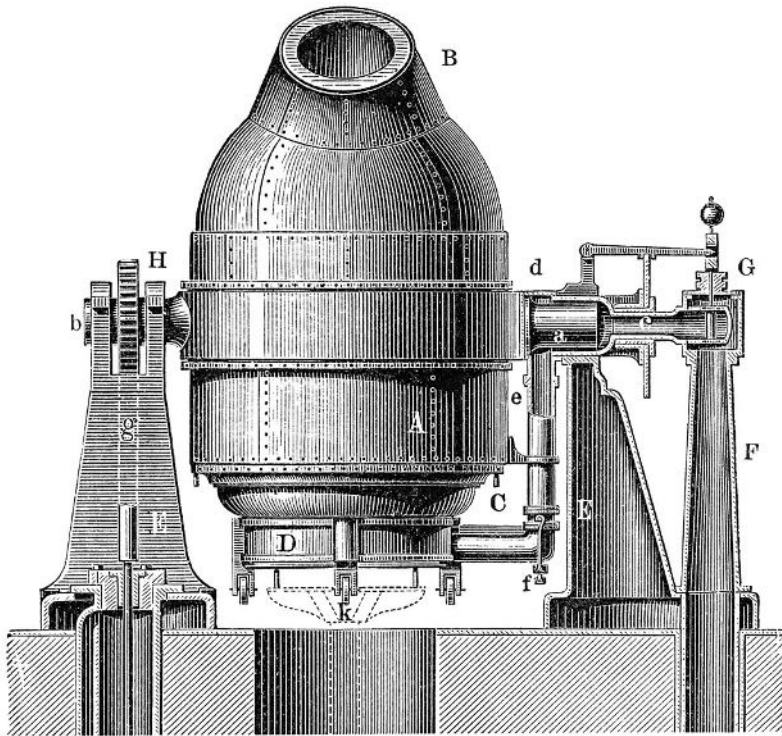

Constantin Meunier, *La coulée à Ougrée*, 1885-90 © Musée d'Art Wallon, Liège.

Laminage ► barres

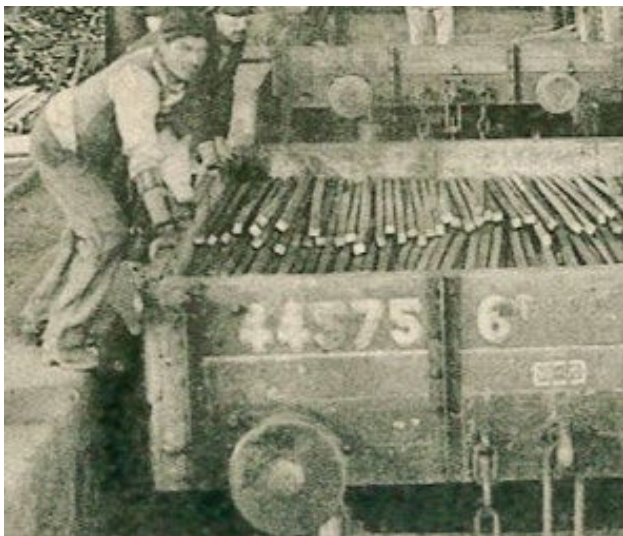
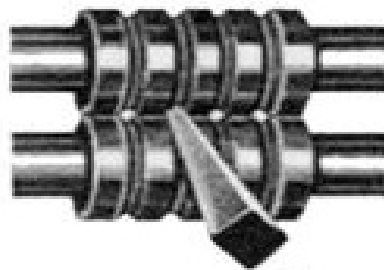
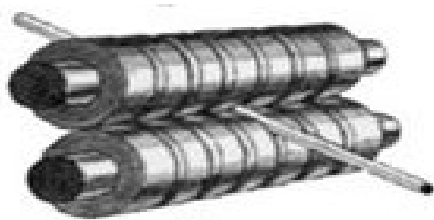
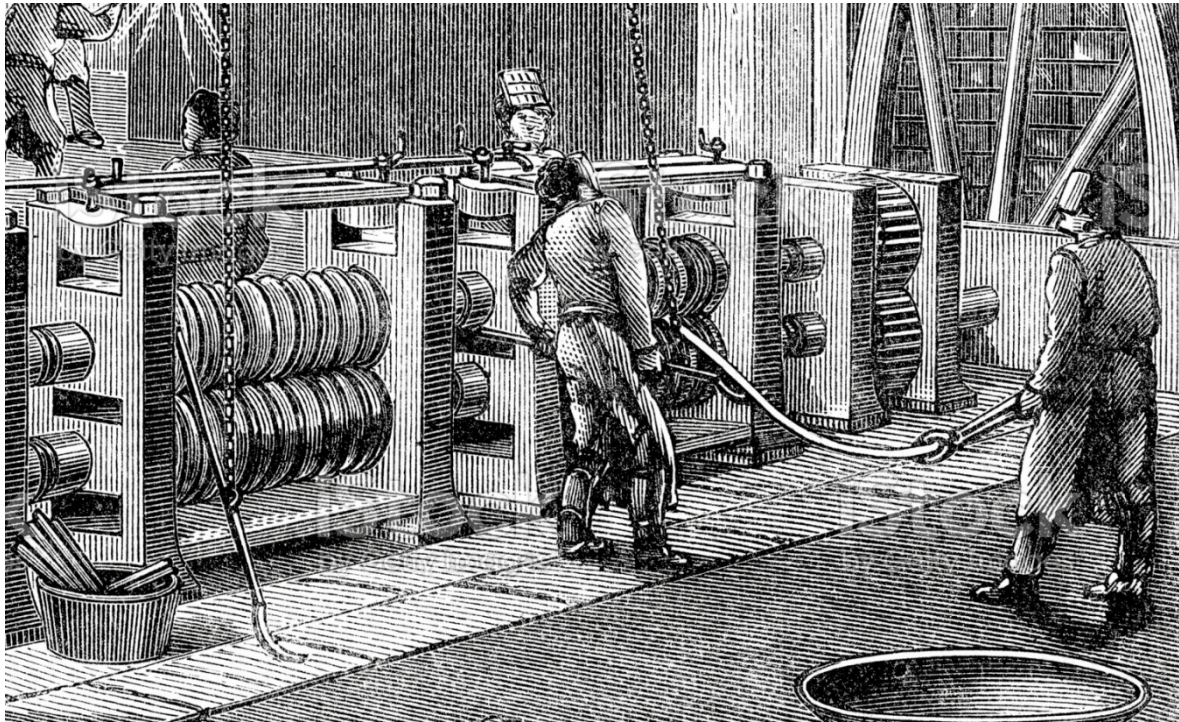

Laminage ► tôles

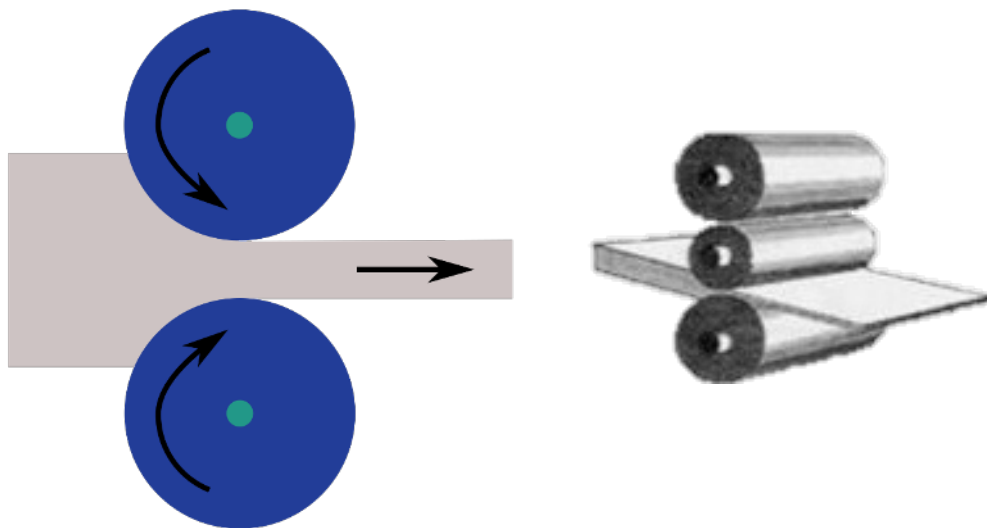

François Bonhommé, *Tôleries des forges d'Abainville*, 1837 (détail)
© Coll. Musée de l'Histoire du Fer Nancy-Jarville - C. Philippot



Laminage ► poutrelles

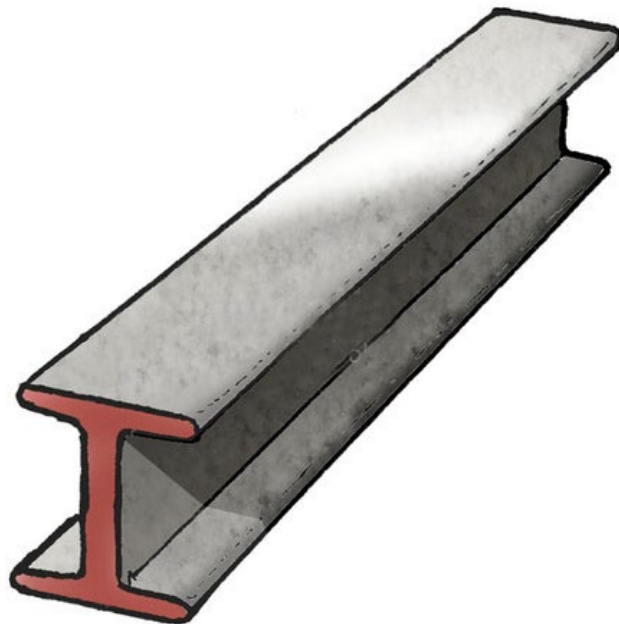
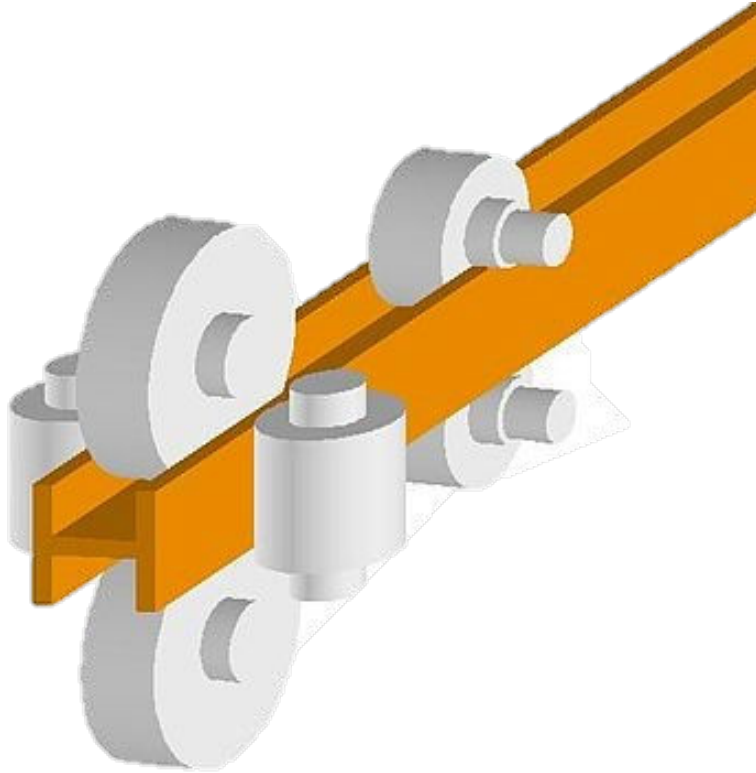

Nouveau procédé pour créer des pièces de grande dimension = la coulée continue

